

General safety instructions



- Only qualified persons over 18 years of age can be permitted to use a stud driver. These persons must know perfectly how the tool works and must follow exactly the manufacturer's instructions and the safety regulations. They must be capable of maintaining the tool.
- The charges and studs used must be **exclusively** those designed and manufactured by SPIT for this tool.
- The SPITFIRE P370 must be checked before use, so as to ensure that the safety devices are working properly and that the front end and the munition carrier are clean. Also ensure that the moving part generally slides well.
- The tool must be loaded just before use. If the tool is not in use, it must be unloaded and put back into its original packing. It must not under any circumstances be transported loaded.
- When firing, the operator must be in a stable position. The tool must be held at right angles to the base material.
- When a firing incident occurs, the tool must be unloaded immediately, taking all necessary precautions. If several incidents occur, inform the manufacturer.
- The SPITFIRE P370 and its chargers must only be transported in their original packing.
- Never point the end of the stud driver at anyone. The driver must always be pointed downwards.
- Never operate the driver with the flat of the hand.
- **The manufacturer must check the condition of the tool, even if it is not used, at least once a year.**
- It is prohibited for unauthorized persons to use a stud driver.
It is prohibited to make any modification to the tool other than those specified in this manual.
- It is prohibited to do stud driving on profiled sheet on a metal structure before having ensured that there is no-one behind it.
- Fixing must not be attempted at a point where the profiled sheet support iron has been damaged or is defective. Fixing must be done at least 2 cm away from this area.
- It is prohibited to attempt fixing on materials which are not rigid or strong enough: hollow brick, plasterboard, slate, etc.
- It is prohibited to drive studs into brittle, hard materials, like cast iron, hardened steel, marble or granite.
- It is prohibited to do any fixing on concrete less than 10 cm from the edges.
It is prohibited to use a stud driver in workshops or other premises where there are explosion risks.
- When using the tool, the user and bystanders must wear suitable safety glasses, a hard hat and hearing protection.

General

GB

- The SPITFIRE P370 is a **high-tech** stud driver.
 - Automatic rising of the inertia block
 - Automatic feeding of studs
 - Automatic feeding of charges
- It is designed for fixing on concrete and steel.
- It is an indirect firing tool, of class A symbol A*, complying with French standards NFE 71-100 and 71-101.
- The SPITFIRE P370 requires two conditions to obtain percussion:
 - To be held firmly resting against the support.
 - To press the trigger.
- Detailed instructions for use are presented in the following pages of this manual. It is essential to familiarize yourself with them before using your SPITFIRE P370.

**This tool is approved by the St-Etienne
Testing Stand under n° 001137**

Technical characteristics

SPITFIRE P370

Category	Indirect firing - class A Symbol A*
	French standards: NFE 71100-71101
Approval	CIP no. 001137
Length without magazine	440 mm
Length with magazine	455 mm
Weight without magazine	2.7 kg
Weight with magazine	2.875 kg
Automatic rising of the inertia block	
Strength setting with indicator	
Magazine capacity	10 studs
Possibility of indexing of magazine 4 positions	

CHARGES

Compliance with French standards	NFE 71-100 and E 71-101 and C. I. P. regulations
Calibre	6.3 / 10

Strength

Brown	very light
Green	light
Yellow	medium
Red	heavy
10 unit charger disc	
Box of 10 discs	

STUDS

Studs without a strip	box of 100 units
Studs with a strip	box of 500 units + 1 rubber spring



Using the tool

Fitting the charger disc

- Unlock the cover (see fig. 1).
- Put the disc correctly into its housing
- Close the cover

GB

Inserting the stud (without a magazine)

- Insert the stud in the stud guide until it is held by the plastic guide (see fig. 2).



Never use the flat of the hand to push the stud back

Pin indicating presence of studs in the magazine

- When one or more studs are in the magazine, it is impossible to insert another strip (see fig. 3).
- The projecting pin indicates the presence of studs in the magazine

Inserting a strip of studs (with a magazine)

- Unlock the magazine's cover (see fig. 4).
- Pull the magazine cover back
- Insert the strip of studs
- Close the magazine cover (automatic locking)





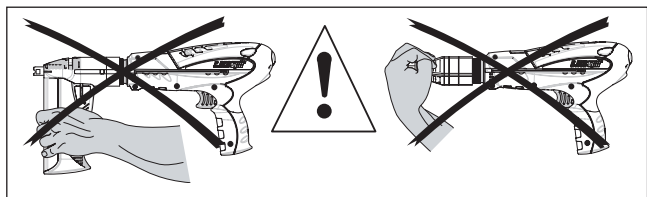



Firing

- Apply the tool at right angles to the material (see fig. 5).
- Hold the tool with both hands, exerting forward pressure, and press the trigger. .



Using the tool

Choosing the stud

Standard applications		Length		Designation	Code		
		thread	stud				
Concrete consumables 	C9 rivet head stud 		20	C 9-20	032740		
			25	C 9-25	032520		
			30	C 9-30	032530		
			35	C 9-35	032540		
			40	C 9-40	032550		
			50	C 9-50	032560		
			60	C 9-60	032570		
			70	C 9-70	032580		
	With pre-drivning			80	C 9-80	032590	
				90	C 9-90	032600	
	Rivet head stud CR9 Ø 14 washer 			25	CR 9-25	032070	
				30	CR 9-30	032100	
				40	CR 9-40	032090	
				50	CR 9-50	032010	
				60	CR 9-60	032020	
Strip stud 			20	C 9-20	011330		
			25	C 9-25	011331		
			30	C 9-30	011332		
			35	C 9-35	011333		
			40	C 9-40	011334		
			50	C 9-50	011335		
			60	C 9-60	011336		
Nota : accessories with pre-fitted studs can be used (Studs - Posibanche - A Clip)							
Steel consumables 	SC9 rivet head stud 		15	SC 9-15	032500		
			20	SC 9-20	032510		
			25	SC 9-25	032950		
			30	SC 9-30	032930		
			35	SC 9-35	032940		
			40	SC 9-40	032920		
			50	SC 9-50	032910		
			60	SC 9-60	032900		
		70	SC 9-70	032890			
	SA9 rivet head stud 			Ø 6 x 100			
		6	21	SA 9-6 6/21	034820		
		10	25	SA 9-6 10/25	034850		
		15	30	SA 9-6 15/30	034900		
				Ø 7 x 150			
		6	21	SA 9-7 6/21	034000		
		10	25	SA 9-7 10/25	034050		
		15	30	SA 9-7 15/30	034070		
		for Ø 8, use the SPIT P250					
		Strip stud 			15	SC 9-15	011340
				20	SC 9-20	011341	
				25	SC 9-25	011342	
				30	SC 9-30	011343	
				35	SC 9-35	011344	
			40	SC 9-40	011345		
			50	SC 9-50	011346		
		60	SC 9-60	011347			

Using the tool

Choosing the charge

(see fig. 6)

- **031740** brown 6.3/10 disc charge - very light
- **031600** green 6.3/10 disc charge - light
- **031700** yellow 6.3/10 disc charge - medium
- **011658** red 6.3/10 disc charge - heavy

Choosing the strength

(see fig. 7)

■ **Tips :**

Choose according to :

- the nature and hardness of the support material
- the length of the stud
- the nature of the part to be fixed

Proceed by successive trials, beginning with the lightest strength, then increase if necessary.

If the charge has misfired, wait for 20 seconds, keeping the tool on the work surface, then stop pressing in order to reset the percussion system and to resume firing.

Removing the charger disc

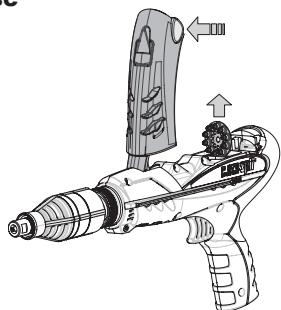

- Unlock the cover
- Remove the disc



The tool must always be emptied after use and before storage in the box. Partially used charger discs must be kept for later use.

Checking the wear parts

- The tool is equipped with a rubber spring (3) (for the return of the inertia block), an inertia block + insulation ring assembly (2) (see fig. 8).
- These parts must be checked at regular intervals

Wear part	Check
Spring (3)	- length (min. 161 mm) - Condition (cuts, wear, etc.)
Insulation ring + inertia block (2)	- Thickness (mini 4 mm) - Condition (cuts, wear, etc.) - No chipped part on the inertia block

Front part



Always unload the tool:

- on completion of work,
- before changing any parts (inertia block, dampers, etc.)
- before doing any cleaning or maintenance

Disassembly

- Hold the tool vertical, resting on the back (see **fig. 9**)
 - Unscrew the tool's nose (stud guide or magazine). If the effort seems too great, use a 16 mm spanner.
- Take out the inertia block with the ring and the spring (see **fig. 10**)
- Unscrew and take out the barrel assembly (push the barrel downwards and turn (see **fig. 11**))

Cleaning

Use the cleaning accessories contained in the box.

Cleaning the front part of the tool and in particular the inside bore of the barrel holder is necessary every 2000 firings or each day if the tool is used in light strength.

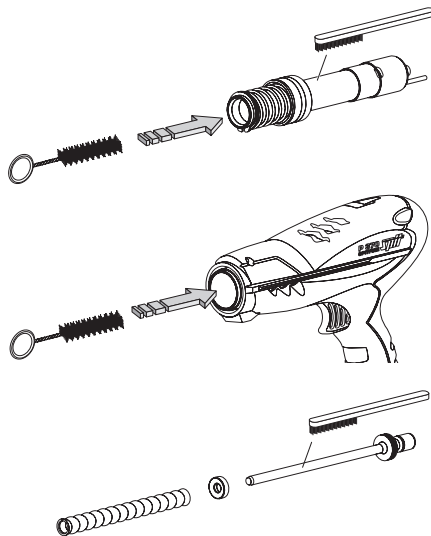

- Cleaning of the inside of the barrel (medium sponge), of the outside with the brush.

- Cleaning of the handle bore (brush + sponge)

- Cleaning of inertia block (brush the rod)
 - Check the condition of the spring (min. length 161 mm). If necessary, use the marks on the handle's casing.
 - Check the condition of the insulation ring.

- To check the wear parts, refer to the previous chapter.

Cleaning (continued)

Damage to the end of the inertia block can be the cause of poor fixing:

- fixing not at right angles
- shearing of the stud on penetration

- Check the wear or possible deformation of the inertia block. Deformation of the end can be trued up by grinding up to 3 mm by making a chamfer.

Keep the ground surface at right angles to the centre line of the inertia block.



TIPS

Powder-actuated tools require regular maintenance to remove the carbon deposited by combustion fumes. Whenever the tool requires unusual force, or when there is a lack of strength or percussion of the charge without driving in the stud, dismantle the front part and clean the bore of the barrel, the charge and the inertia block.



It is essential to use SPIT lubricant for maintenance. We recommend wiping parts after oiling them.

Reassembly

Reassembly is the reverse of disassembly

- Position the barrel's groove at the top (see **fig. 12**)
- Insert the barrel assembly in the handle and screw the knurled ring
- After reassembly, check that the barrel slides properly in the handle
- Insert the insulation ring on the inertia block's rod
Insert the rubber ring on the rod
- Position the inertia block assembly in the barrel
- Screw up the magazine (until the first "click" and turn once) or the stud guide.

Troubleshooting

EFFECTS	CAUSES	REMEDIES
Malfunctioning of the charge feed or percussion device	<ul style="list-style-type: none"> - Insufficient force on the tool when resting it on the support - The charger disc has not turned - Munition carrier sleeve not sliding properly - Malfunctioning of the charger disc - No more studs in the magazine - Barrel dirty - Tool too hot 	<ul style="list-style-type: none"> - Hold the tool resting on the support - Check the condition of the small bar - Disassemble, clean - Check it - See magazine pin - Disassemble, clean - Allow to cool
Barrel jammed at the back	<ul style="list-style-type: none"> - Moving assembly (barrel) dirty - Tool too hot 	<ul style="list-style-type: none"> - Disassemble, clean - Allow to cool
Lack of power or fluctuation in power	<ul style="list-style-type: none"> - Deterioration of the inertia block - Inertia block very eroded - Deterioration of the spring - Deterioration of the insulation ring 	<ul style="list-style-type: none"> - Change it - Change it - Change it - Change it
Too much force needed to rest the tool on the support	<ul style="list-style-type: none"> - Barrel dirty - Presence of foreign matter 	<ul style="list-style-type: none"> - Clean, oil and reassemble - Clean, oil and reassemble
Impossible to close the magazine's cover	<ul style="list-style-type: none"> - More than 10 studs in the magazine - Stud guide not sliding properly 	<ul style="list-style-type: none"> - Remove the studs - Contact SPIT's after-sales service department
Jamming of the inertia block	<ul style="list-style-type: none"> - Strip residues stuck 	<ul style="list-style-type: none"> - Clean
Poor stud feed	<ul style="list-style-type: none"> - Presence of residues in the magazine - Stud guide not sliding properly 	<ul style="list-style-type: none"> - Clean - Contact SPIT's after-sales service department



P370 BACK PART

Only your SPIT agent or his representative is authorized to disassemble this assembly.